

Edge Gateway 500 MK2 Series

Version:
v1.0

Date:
12.12.2024



Contents

1	Copyright	2
2	Regulatory Compliances	3
2.1	CE and UKCA Notice	3
2.2	FCC PART 15 VERIFICATION STATEMENT	4
2.3	ICED-003 ISSUE 7 VERIFICATION STATEMENT	4
3	Safety Instructions	5
4	Product Specifications	6
4.1	Technical Details	7
5	Dimensions	8
5.1	System Drawing	9
5.2	Mainboard Block Diagram	10
6	Power Supply	11
7	Power Consumption	12
8	Interfaces and Connections	13
8.1	EG400 Mk2 & EG500 Mk2	14
8.2	EG500 Mk2 (with optional Radio Module)	16
9	Radio Modules (Relevant for EG500 Mk2 Models)	17
9.1	Radio Frequencies	17

1 Copyright

Copyright and Trademarks, 2024 Publishing. All Rights Reserved

This manual, software and firmware described in it are copyrighted by their respective owners and protected under the laws of the Universal Copyright Convention. You may not reproduce, transmit, transcribe, store in a retrieval system, or translate into any language, in any form or by any means, electronic, mechanical, magnetic, optical, chemical, biological, molecular, manual, or otherwise, any part of this publication without the express written permission of the publisher.

All products and trade names described within are mentioned for identification purpose only. No affiliation with or endorsement of the manufacturer is made or implied. Product names and brands appearing in this manual are registered trademarks of their respective companies. The information published herein has been checked for accuracy as of publishing time. No representation or warranties regarding the fitness of this document for any use are made or implied by the publisher.

We reserve the right to revise this document or make changes in the specifications of the product described therein at any time without notice and without obligation to notify any person of such revision or change.

2 Regulatory Compliances

2.1 CE and UKCA Notice

The EG500 Mk2 Series may contain the following LTE Module: Trademark: Quectel Model Number: EM05-G

Complies with: RADIO EQUIPMENT DIRECTIVE 2014/53/EU and Radio Equipment Regulations 2017 (SI 2017 No. 1206)

Article 3.1a Safety: Low Voltage Directive 2014/35/EU

- EN 62368-1:2018
- EN IEC 62368-1 :2020+A11:2020
- BS EN IEC 62368-1 :2020+A11:2020
- EN IEC 62368-1 :2020+A11:2020 (module)

Article 3.1a Health:

- EN IEC 62311:2020 (module)

Article 3.1b EMC: EMC Directive 2014/30/EU

- EN 55032:2015+AC:2016
- EN 55035:2017
- EN 61000-3-2:2014
- EN 61000-3-3:2013
- EN 61000-4-2:2009
- EN 61000-4-3:2006+A1
- EN 61000-4-4:2012
- EN 61000-4-5:2014+A1:2017
- EN 61000-4-6:2014+AC:2015
- EN 61000-4-8:2010
- EN 61000-4-11:2004+A1:2017
- BS EN 50121-4:2006+A1:2019
- BS EN 61000-6-4:2014
- BS EN 61000-4-2:2009
- BS EN IEC 61000-4-3:2020
- BS EN 61000-4-4:2012
- BS EN 61000-4-5:2014+A1:2017
- BS EN 61000-4-6:2014
- BS EN 61000-4-8:2010
- EN 301 489-1 V2.2.3 (module)
- Draft EN 301 489-19 V2.2.0 (module)

- EN 301 489-52 V1.2.1 (module)
- EN 55032:2015+A1:2020 (module)
- EN 55035:2017+A11:2020 (module)

Article 3.2 Radio:

- EN 301 908-1 V15.1.1 (module)
- EN 301 908-2 V13.1.1 (module)
- EN 301 908-13 V13.2.1 (module)
- EN 303 413 V1.2.1 (module)

RoHS 2 Directive 2011/65/EU & 2015/863/EU

- Exemption(s) used:
 - 6a, 6b, 6c

The corresponding markings are located on the device:



2.2 FCC PART 15 VERIFICATION STATEMENT

WARNING

This equipment has been tested and found to comply with the limits for a Class A digital device, pursuant to part 15 of the FCC Rules. These limits are designed to provide reasonable protection against harmful interference when the equipment is operated in a commercial environment. This equipment generates, uses, and can radiate radio frequency energy and, if not installed and used in accordance with the instruction manual, may cause harmful interference to radio communications. Operation of this equipment in a residential area is likely to cause harmful interference in which case the user will be required to correct the interference at his own expense.

Notice: The changes or modifications not expressly approved by the party responsible for compliance could void the user's authority to operate the equipment.

This device complies with part 15 of the FCC Rules. Operation is subject to the following two conditions: (1) This device may not cause harmful interference, and (2) this device must accept any interference received, including interference that may cause undesired operation.

May Contain transmitter module:

- RYK-WNFQ262ACNIBT
- XMR2021EM05G

2.3 ICED-003 ISSUE 7 VERIFICATION STATEMENT

CAN ICES3(A)/NMB3(A)

This device complies with CAN ICES-003 Issue 7 Class A. Operation is subject to the following two conditions: (1) This device may not cause harmful interference, and (2) this device must accept any interference received, including interference that may cause undesired operation.

May Contain transmitter module:

- 2417C-EM75T
- 6158A-FQ262ACNIBT

3 Safety Instructions

Please read these instructions carefully and retain them for future reference.

1. Disconnect this equipment from the power outlet before cleaning. Do not use liquid or sprayed detergent for cleaning. Use a moist cloth or sheet.
2. Keep this equipment away from humidity.
3. Ensure the power cord is positioned to prevent tripping hazards and do not place anything on top of it.
4. Pay attention to all cautions and warnings on the equipment.
5. If the equipment is not used for an extended period, disconnect it from the main power to avoid damage from transient over-voltage.
6. **Prolonged usage with less than 12V may damage the PSU or destroy the Mainboard**
7. Never pour any liquid into openings as this could cause fire or electrical shock.
8. Have the equipment checked by service personnel if:
 - The power cord or plug is damaged.
 - Liquid has penetrated the equipment.
 - The equipment has been exposed to moisture in a condensation environment.
 - The equipment does not function properly, or you cannot get it to work by following the user manual.
 - The equipment has been dropped and damaged.
9. Do not leave this equipment in an unconditioned environment, with storage temperatures below -20 degrees or above 60 degrees Celsius for extended periods, as this may damage the equipment.
10. Unplug the power cord when performing any service or adding optional kits.
11. Lithium Battery Caution:
 - Risk of explosion if the battery is replaced incorrectly. Replace only with the original or an equivalent type recommended by the manufacturer. Dispose of used batteries according to the manufacturer's instructions.
 - Do not remove the cover, and ensure no user-serviceable components are inside. Take the unit to a service center for service and repair.





4 Product Specifications

4.1 Technical Details

Feature	Specification	EG400 Mk2	EG500 Mk2 Headless	EG500 Mk2
Processor	CPU	Intel Atom® x6211E Processor, 1.3/3.0 GHz	Intel Atom® x6200FE Processor, 1.0 GHz	Intel Atom® x6413E Processor, 1.5/3.0 GHz
Memory	RAM	4 GB LP-DDR4	4 GB LP-DDR4	8/16 GB LP-DDR4
Storage		100 GB free storage optional: expandable up to 1 TB	100 GB free storage optional: expandable up to 1 TB	100 GB free storage optional: expandable up to 1 TB
Security	TPM	TPM 2.0 (functions: Azure DPS)	TPM 2.0 (functions: Azure DPS)	TPM 2.0 (functions: Azure DPS)
I/O Ports	HDMI	1	-	1
	Gigabit Ethernet	2x 2.5 GbE (i226-V)	3x 2.5 GbE (i226-IT)	3x 2.5 GbE (i226-IT)
	USB 3.0	3	1	3
	USB 2.0	1	-	1
	Serial Ports	-	1 RS232 (RS485 optional) (TX/RX only)	1 RS232 (RS485 optional) (TX/RX only)
	DIO	-	1 DI, 12-24V 1 DO, 12-24V, max. 2 A, output voltage defined by DC input	1 DI, 12-24V 1 DO, 12-24V, max. 2 A, output voltage defined by DC input
Connectivity	LTE (optional)	-	4G	4G
	WLAN (optional)	-	-	Optional (8GB version only)
Expansion	SIM Slot	1 push-push Type Nano-SIM Slot	1 push-push Type Nano-SIM Slot	1 push-push Type Nano-SIM Slot
Additional	Watchdog Timer	System Reset, Programmable via Software from 1 to 255 Seconds	System Reset, Programmable via Software from 1 to 255 Seconds	System Reset, Programmable via Software from 1 to 255 Seconds
Environmental	Operating Temperature	-20° to 60° C	-20° to 60° C	-20° to 60° C
	Storage Temperature	-40° to 85° C	-40° to 85° C	-40° to 85° C
	Humidity	5% to 95% non-condensing	5% to 95% non-condensing	5% to 95% non-condensing

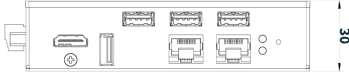
5 Dimensions

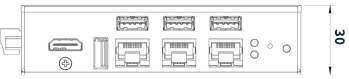
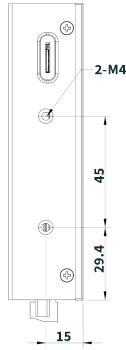
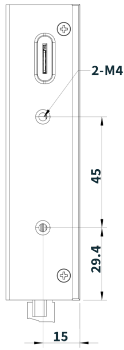
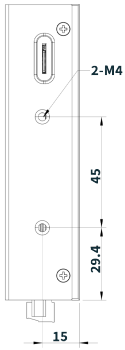
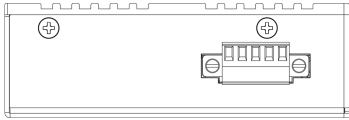
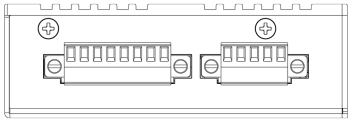
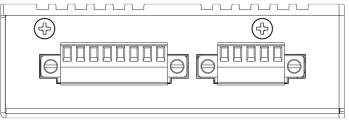
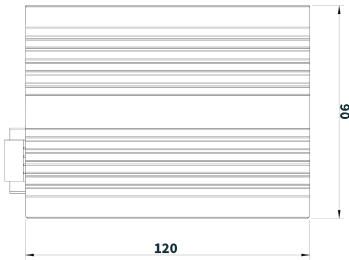
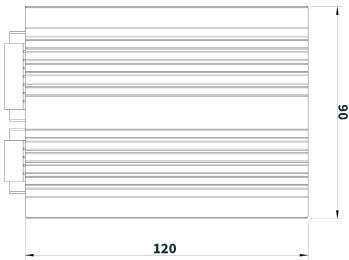
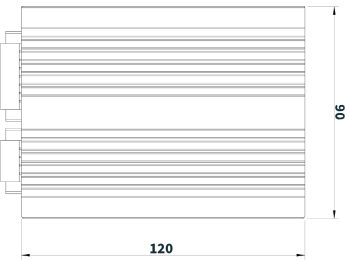
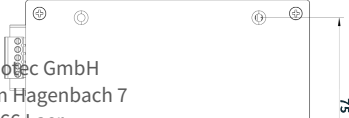
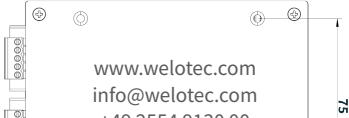
5.1 System Drawing

EG400 Mk2	EG500 Mk2 Headless	EG500 Mk2
		
		
		
		
 <p data-bbox="191 1990 354 2066"> Welotec GmbH Zum Hagenbach 7 48366 Laer </p>	 <p data-bbox="727 1990 896 2066"> www.welotec.com info@welotec.com +49 2554 9130 00 </p>	 <p data-bbox="1377 2024 1429 2051">Page 9</p>

5.2 Mainboard Block Diagram

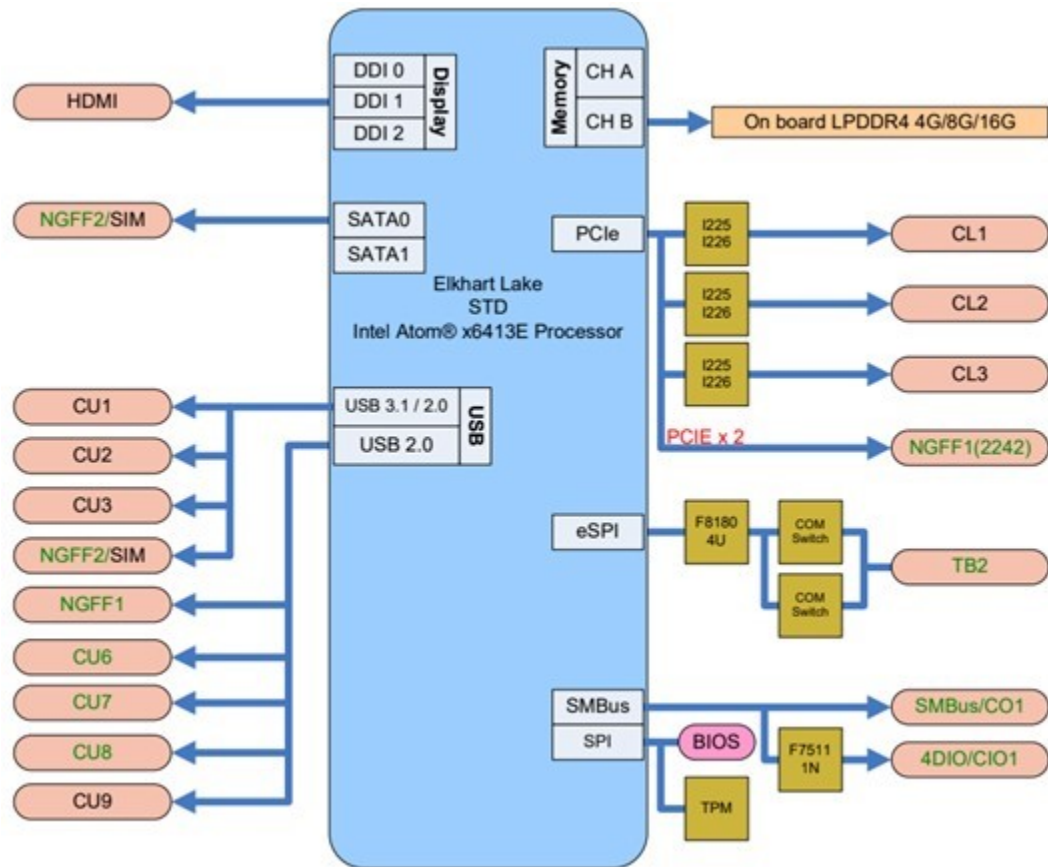

6 Power Supply



Use the terminal block to connect the Edge Gateway to a 12-24V DC power source.

Pin	Description
Pin 0 – VCC	V+ 12-24V
Pin 1 – SW	External power switch
Pin 2 – NC	Not connected
Pin 3 – GND	Ground
Pin 4 – GND	Ground

7 Power Consumption

Item	Specification
CPU	Intel Atom® x6413E Processor
RAM	LP-DDR4 8GB 3200MHz
Operating System	Windows 10 IoT 2021 LTSC
Test Program	3DMark06
Storage	128GB mSATA







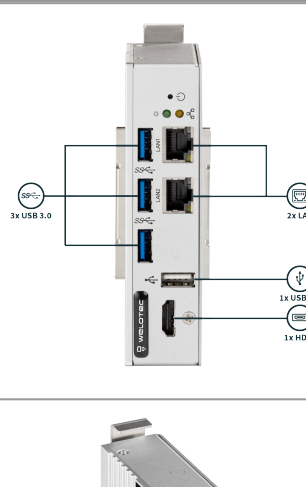
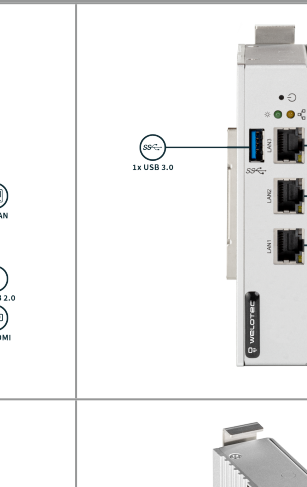

Note: Results are for reference only!

Voltage	Power Off	Start-up Max	Start-up Stable	Burn-in Max	Shut Down
12V	0.07A	1.48A	0.63A	1.70A	1.31A
24V	0.04A	0.73A	0.35A	0.91A	0.65A

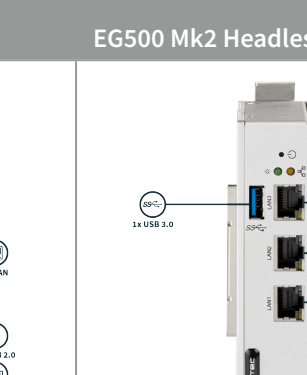
Note: Power consumption depends on options and software.

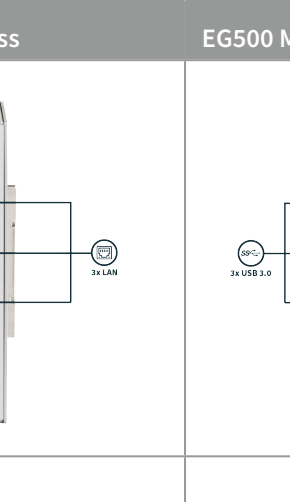
8 Interfaces and Connections

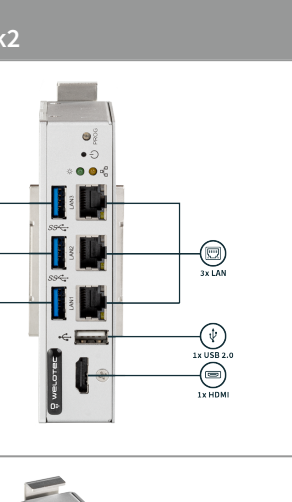
8.1 EG400 Mk2 & EG500 Mk2

EG400 Mk2	EG500 Mk2 Headless	EG500 Mk2
		
		
		
		

8.2 EG500 Mk2 (with optional Radio Module)

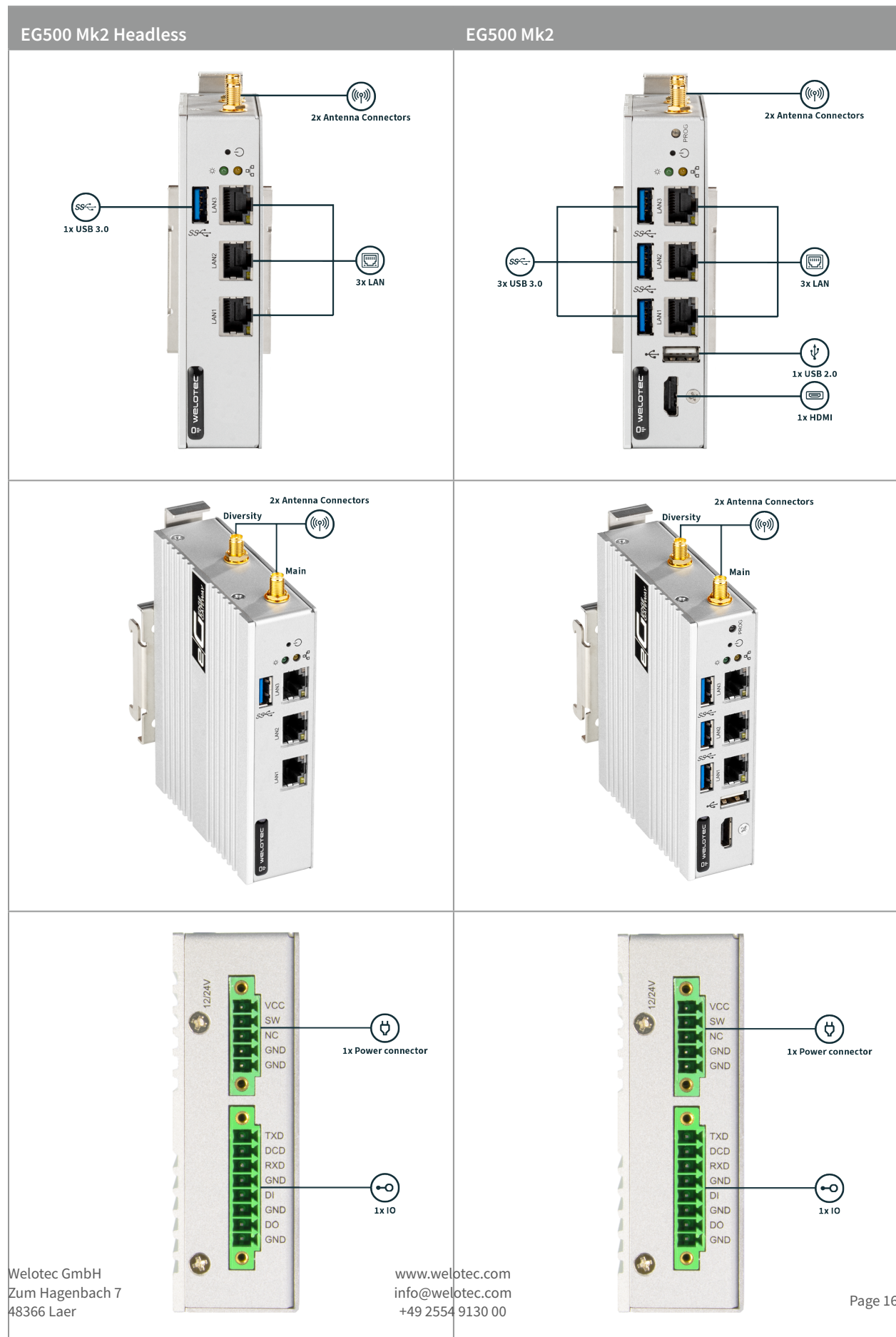

9 Radio Modules (Relevant for EG500 Mk2 Models)

The EG500 Mk2 may contain the following RF Modules:

- Quectel EM05-G
- SparkLAN WNFQ-262ACNI(BT)

LTE:

Quectel EM05-G	Supported Bands
LTE	FDD B1/ B2/ B3/ B4/ B5/ B7/B8/ B12/B13/B14/ B18/ B19/B20/ B25/ B26/ B28/B66/B71TDD B38/ B39/ B40/ B41
WCDMA	B1/ B2/ B4/ B5/ B6/ B8/ B19

WiFi

SparkLAN WNFQ-262ACNI(BT)	
Operating Frequency	IEEE 802.11ac/a/b/g/nISM Band: 2.412GHz~2.484GHz, 5.150GHz~5.850GHz*Subject to local regulations

9.1 Radio Frequencies

9.1.1 4G LTE Europe

Band	Frequency Range Down	Frequency Range Up	Max Transmission Power
Band 1	2110 MHz - 2170 MHz	1920 MHz - 1980 MHz	199 mW
Band 3	1805 MHz - 1880 MHz	1710 MHz - 1785 MHz	199 mW
Band 7	2620 MHz - 2690 MHz	2500 MHz - 2570 MHz	199 mW
Band 8	925 MHz - 960 MHz	880 MHz - 915 MHz	199 mW
Band 20	791 MHz - 821 MHz	832 MHz - 862 MHz	199 mW
Band 28	758 MHz - 803 MHz	703 MHz - 748 MHz	199 mW
Band 38	2570 MHz - 2620 MHz	2570 MHz - 2620 MHz	199 mW
Band 41	2496 MHz - 2690 MHz	2496 MHz - 2690 MHz	199 mW

9.1.2 3G UMTS Europe

Band	Frequency Range Down	Frequency Range Up	Max Transmission Power
Band 1	2110 MHz - 2170 MHz	1920 MHz - 1980 MHz	251 mW
Band 8	925 MHz - 960 MHz	880 MHz - 915 MHz	251 mW

9.1.3 WiFi Output Power & Sensitivity

IEEE Standard	Data Rate	Tx \pm 2dBm	Rx Sensitivity
802.11b	11Mbps	18dBm	⊠-85dBm
802.11g	54Mbps	14.5dBm	⊠-71dBm
802.11n / 2.4GHz (HT20)	MCS7	14dBm (1TX)17dBm (2TX)	⊠-67dBm
802.11n / 2.4GHz (HT40)	MCS7	13.5dBm (1TX)16.5dBm (2TX)	⊠-65dBm
802.11a	54Mbps	14dBm	⊠-75dBm
802.11n / 5GHz (HT20)	MCS7	13dBm (1TX)16dBm (2TX)	⊠-71dBm
802.11n / 5GHz (HT40)	MCS7	13dBm (1TX)16dBm (2TX)	⊠-67dBm
802.11ac (VHT80)	MCS9	11dBm (1TX)14dBm (2TX)	⊠-57dBm

Notes

- **Down:** Refers to the downlink frequency range.
- **Up:** Refers to the uplink frequency range.
- **Max Transmission Power:** Maximum power at which the device transmits.